

The Patents Act, 1970

**Qualifying Examinations under Sections 126 of the
Patents Act, 1970 (As amended & Updated)**

drafting and Interpretation of Patents^{ent} specification
and other Documents, September, 2000.

Paper - II

Total Marks - 100.

Time - 2½ hours.

Q. 1. Answer any five questions (each question carries equal marks).

- a) Your client Mr. D. Bajaj from Pune informs you that he wishes to file an application for Patent outside India and enquires about the procedure for obtaining prior permission of the Govt. of India. Write a letter advising your client explaining about the ^{as} omission of section 39 with effect from 01.01.95 by Patents (Amendment) Act, 1999.
- b) Your client, a pharmaceutical Company from USA informs you that based on his application for Patent filed in India under Section 5(2) of the Patents ^(Amendment) Act, 1999, he wishes to file an application for grant of exclusive marketing rights in India. Write a letter advising your client regarding the provisions under section 24A & 24B of the Act & documents required for filing application for grant of EMR on Form 27, fees required etc.
- c) your client Mr. Ashok Kumar Roy from Calcutta states that he is interested in filing an International application for Patent under PCT with the priority of the application for Patent filed at the Patent Office, Calcutta on 01.01.2000. He further states that he is interested in grant of Patent in UK, Germany, France, USA, Japan, South Korea, China, Canada, Australia, Sri Lanka, Brazil & ^{Israel} Israel but at the same time he has made reference of limited resources available with him. Write a letter with details regarding requirements under PCT with reference of request form,

: 2 :

transmittal fee, international fees, fees for certified copy etc to your client.

d) Your client informs you that a Patented article is now of high demand in the market. From reliable sources he has learned that the manufacturer of the article might be creating artificial crises in the market by over quoting the price of the article. He also informs you that he is capable of manufacturing the said article and will be able to sell at a lower price. Your client is also very much eager to start manufacturing the same immediately. What course of action you will suggest to your client so that his wish may be fulfilled.

e) Your client's Application for Patent ^{has} been granted by the Controller, write a letter to your client informing him about the right he is now holding with respect to said patent and action required to keep the patent in force.

f) Write a letter to your Associates in Foreign Country stating the changes in the First Schedule (regarding fees) and the Second Schedule (regarding forms) that have taken place with effect from 02.06.1999 and the professional service charges you intend to increase by X times the existing changes.

g) Write a letter to your client stating the changes in Rule 4 of the Patents Rules, 1972, appropriate office for filing application for Patent w.e.f 02.06.1999 making special reference to "the place from where the invention actually originated" and advise your client how to proceed in their forthcoming application for Patent.

Or

Your company is having offices in three metros where patent office is situated. Write a short note stating how you may take advantage of amended Rule 4 (1) (b) for filing application for Patents in India for your clients of foreign countries.

h) India has signed the GATT Agreement~~s~~ establishing the World Trade Organisation (WTO) which came into force on 01.01.95. Moreover Agreement on TRIPs is a part of the WTO Agreement~~s~~, and Patent~~s~~ is a form of IPR covered by TRIPs. With a view to meet India's obligations under the above said agreement, state the ~~x~~ necessary amendments which should have been made in the Patents law on or before 01.01.2000 and which are required on or before 01.01.2005 respectively.

(Marks - 55)

Q. 2. Your client from USA, M/s SICO Incorporated, a corporation organised and existing under the laws of the states of Minnesota, United States of America of 7525 Cahill Road, Minneapolis, Minnesota 55435, USA wishes to file an application for Patent in ~~M~~ India, requests you to draft an Assignment of invention from the inventor which ~~must~~ should be filed alongwith the application with the details as given under :

- a) Inventors names in full 1) Thomas Luedka, 2) Randy Aagaard,
3) Carl Niemi.
- b) Inventors Address 1) 14710 Dominica Court, Apple valley, Minnesota 55124, USA
2) 25125 Glen Road, Minnesota 55331, USA.
3) 6609 17th Anenue, Richfield Minnesota 55434, USA.
- c) Title of inventions - Weaving machine.
- d) Witnesses 1) Andrew Shea, 15200, Forest circle, Minnesota 55143, USA.
2) Mary Geez, 15732, Spring Valley Minesota 55200, USA.

(Marks - 15)

Q.3. Your client informs you that :

He has invented an improved water level indicator suitable for use in connection with ground level water cisterns or tanks in a public place.

The object of his invention is to avoid a large indicator which is liable to be interfered with by mischievous persons. He has invented a small indicator placed far away at higher level and most of the working parts are inside the tank and the indicator indicates full, half and empty position of the liquid inside the tanks.

His device is illustrated in figure 1,2 & 3 of the drawings in which :

Reference letter represents as under :

1. Vessel/tank.
2. float consisting a hollow copper ball.
3. lever
4. projection
5. an eye
6. vertical rod
7. a crank rod
8. a tube
9. a pointer (which moves through an angle of 90°)
10. position of 2 in dotted lines indicates lower position when tank is empty.

Draft a complete specification for your client including statement of claims (Drawing enclosed)

Or

Your client writes as follows :

"Our company has been carrying out research for some time to identify improved antibacterial agents. Recently our investigations have concentrated on a series of aminothiazole diazole derivatives of general formula (I) :

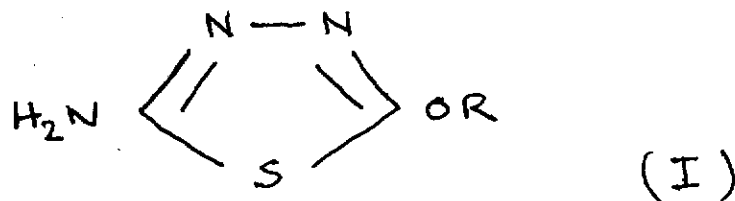

Compounds of formula (I) were prepared, in which R represents a broad range of hydrocarbon substituents. Unfortunately, none were found to possess detectable antibacterial activity. However, a further modification to the aminothiadiazoles to form 4 aminobenzene sulphonamide derivatives of formula (II) led to more success.

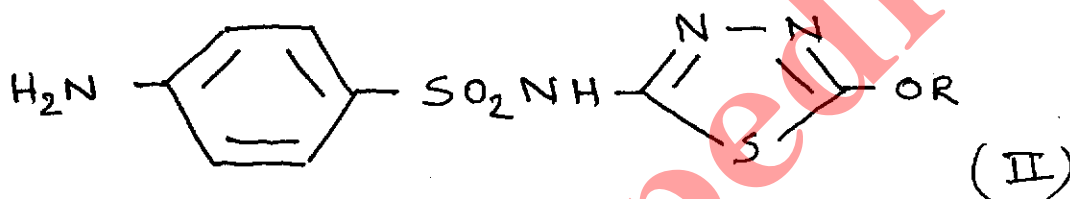

In formula (II), we again made compounds in which R represents the groups corresponding to those in formula (I). Only those in which R is a straight chain alkyl group possess antibacterial activity. Any degree of branching in the group R leads to loss of potency. The compounds which show greatest promise are:

- 2-(4-aminobenzenesulphonamido)-5-ethoxy-1,3,4-thiadiazole; and
 - 2-(4-aminobenzenesulphonamido)-5-n-propoxy-1,3,4-thiadiazole,
- i.e. the compounds of formula (II) in which R represents ethyl and n-propyl respectively.

The length of the alkyl chain does not appear to be critical and however, the structures with up to C-6 alkyl are more readily prepared on a large scale suitable for commercial manufacture.

The sulphonamide derivatives of formula (II) were prepared by the reaction of the thiadiazoles of formula (I) with

4-acetylamino benzenesulphonyl chloride:

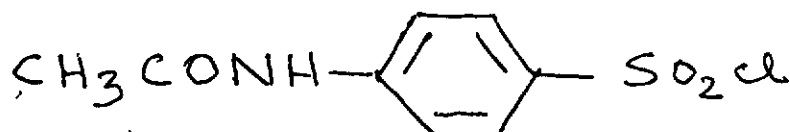

"After the reaction, the acetylamino group may be converted to the desired amino group by hydrolysis. We believe that other amino-protecting groups may be employed which may be conveniently be carried out in the presence of an inert solvent, for example water, acetone, methylene dichloride or benzene, and it is preferably carried out in the presence of an acid-binding agent, for example sodium carbonate, sodium bicarbonate or triethylamine.

"We are aware of Patent A which describes compounds of formula (I) where R represents methyl, ethyl or phenyl, as agents which possess anticonvulsant properties. The compounds of Patent A were prepared by the process which we have employed to prepare our thiadiazoles. No further values of R were disclosed in Patent A. The only further relevant document which we have located is a literature reference, publication B, which describes the chemical modification of the compounds of Patent A to produce benzene-sulphonamide derivatives of structure (III):

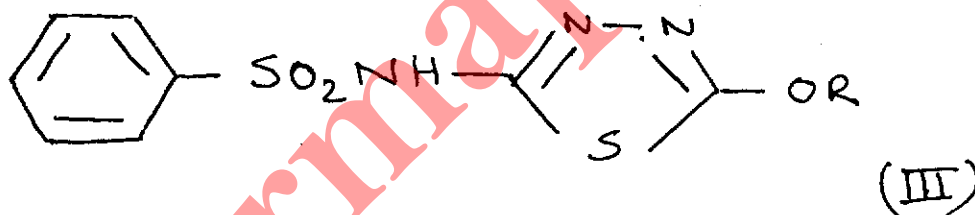

"No utility is described in Publication B for those compounds.

"We would like to cover all aspects of this invention in a single application.

Draft a complete specification for an application for patent for the above said invention to be filed in India.

(Marks- 30)

Contd. P. 7...

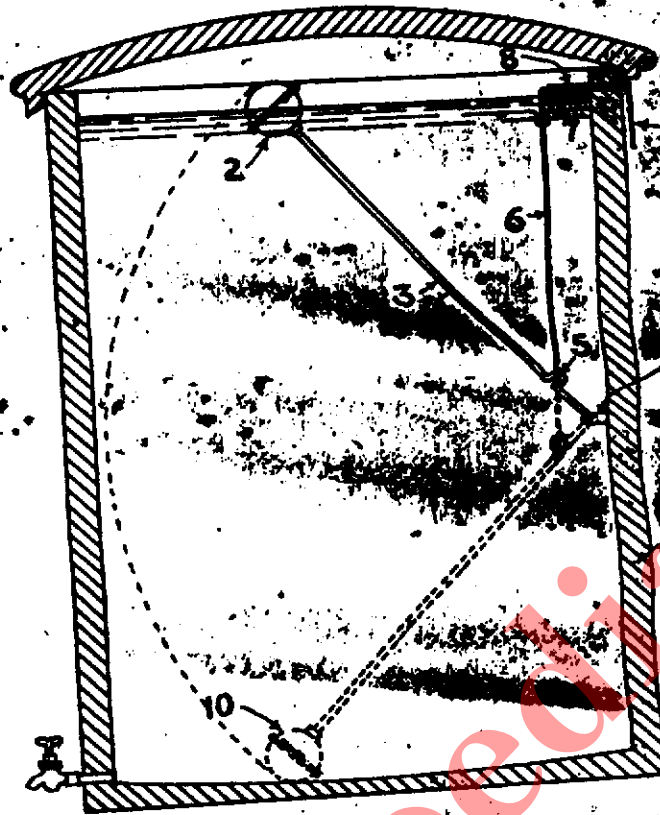

FIG. 1.

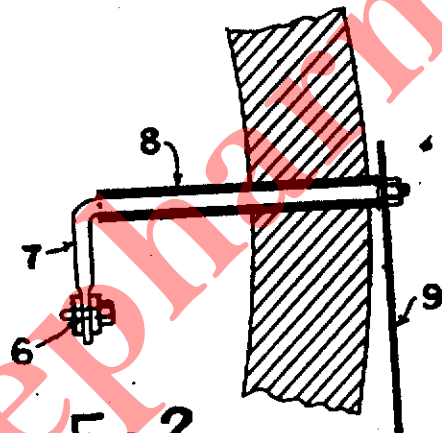

FIG. 2.

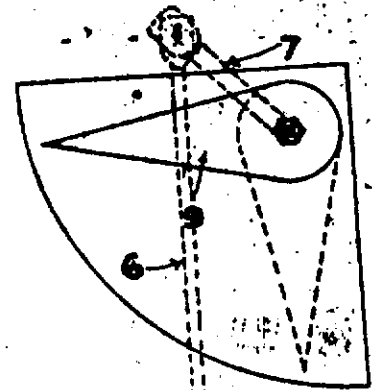

FIG. 3.